

POLIMOR

METALLO

Maniglie / Handles



Polimor maniglie metallo, belle da vedere e da toccare

Polimor metal handles,
nice to be looked
and to be touched

Evoluzione del prodotto e del design

I prodotti Polimor sono in evoluzione costante, essendo la loro ideazione strettamente collegata ai mutamenti estetici e tecnologici degli ambienti d'arredamento ed al cambiamento del modo di vivere moderno.

La ricerca diventa un obiettivo fondamentale, che coinvolge l'aspetto formale, materico e cromatico; nascono, così, prodotti ben equilibrati, che, rispettando gli standard qualitativi, fanno tendenza.

La linea di maniglie in metallo nasce da un processo stilistico indirizzato ad una fascia di mercato più esigente e presenta una collezione che si sviluppa anno dopo anno con uno stile unico, sempre rivolto alla meticolosa cura dei dettagli.

Vengono, così, realizzati prodotti che si abbinano armoniosamente ai mobili che li accolgono, risultando oggetti belli da vedere e piacevoli da toccare.

Design and products in tendency

Polimor products are in constant development, being their creation strictly related to the aesthetical and technological changes of furniture context and to the modern way of living.

As a result, the Research becomes a basic goal, that involves formal, Material and chromatic aspect; following such guide-lines is the right way for the creation of well-balanced items, that, in compliance with the quality standards, forge a new trend. The assortment of metal handles has its origin in a stylistic process, addressed to a high-demanding market range and offers a collection, that evolve year by year with a unique style, always narrowly taking care of the details.

Therefore, the products are perfectly tuned in with the furniture, appearing objects really tactful and nice to be looked.



Polimor maniglie metallo, belle da vedere e da toccare

Polimor metal handles,
nice to be looked
and to be touched

Evoluzione del prodotto e del design

I prodotti Polimor sono in evoluzione costante, essendo la loro ideazione strettamente collegata ai mutamenti estetici e tecnologici degli ambienti d'arredamento ed al cambiamento del modo di vivere moderno. La ricerca diventa un obiettivo fondamentale, che coinvolge l'aspetto formale, materico e cromatico; nascono, così, prodotti ben equilibrati, che, rispettando gli standard qualitativi, fanno tendenza.

La linea di maniglie in metallo nasce da un processo stilistico indirizzato ad una fascia di mercato più esigente e presenta una collezione che si sviluppa anno dopo anno con uno stile unico, sempre rivolto alla meticolosa cura dei dettagli.

Vengono, così, realizzati prodotti che si abbinano armoniosamente ai mobili che li accolgono, risultando oggetti belli da vedere e piacevoli da toccare.

Design and products in tendency

Polimor products are in constant development, being their creation strictly related to the aesthetical and technological changes of furniture context and to the modern way of living. As a result, the Research becomes a basic goal, that involves formal, Material and chromatic aspect; following such guide-lines is the right way for the creation of well-balanced items, that, in compliance with the quality standards, forge a new trend. The assortment of metal handles has its origin in a stylistic process, addressed to a high-demanding market range and offers a collection, that evolve year by year with a unique style, always narrowly taking care of the details.

Therefore, the products are perfectly tuned in with the furniture, appearing objects really tactful and nice to be looked.

Polimor lo stile italiano in tutto il mondo.

Polimor, the Italian
style in the world.

Lo stile italiano è la prerogativa fondamentale per la Divisione Metallo Polimor. La nostra ricerca non si ferma mai. I progetti Polimor danno origine a maniglie di metallo uniche. In tal modo, le forme semplici e minimali si alternano con i volumi più sinuosi e articolati, consentendo un'ampia scelta di applicazione nei distinti mobili d'arredo. Con i migliori stili scelti per voi dal nostro team, le nostre maniglie in metallo sono il frutto di importanti sinergie aziendali, che coniugano eccellenza e creatività. Le finiture sono sia standardizzate per le grandi quantità che personalizzate.

Con le nostre maniglie in metallo esportiamo lo stile italiano in tutto il mondo.

Italian style is the main feature of Polimor production. Our research for the best never stops. Polimor projects give birth to elegant and rich metal handles, with not only minimal designs, but also sinuous and playful styles. As a matter of fact our products are the result of a strong partnership among all divisions of our company. The technical department is only one of the main actors involved in the process. Creativity is added by each one of us. Finishes can be standard or personalized according to the client expectations and desires.

With our metal handles we export Italian style all over the world.



Certifica la qualità, anticipa il futuro!

**Certify the quality,
advance the future!**

POLIMOR & PRODUZIONE

A garanzia del costante impegno profuso per il raggiungimento degli obiettivi di qualità e nella ricerca della reciproca soddisfazione nei rapporti con clienti e fornitori, POLIMOR s.r.l. ha ottenuto la certificazione UNI EN ISO 9001:2008 rilasciata dall'ente certificatore TÜV.

POLIMOR & AMBIENTE

La difesa dell'ambiente è oggi un argomento di vitale importanza. La normativa internazionale UNI EN ISO 14001 è il più diffuso strumento volontario di gestione ambientale destinato alla prevenzione e riduzione dell'impatto ambientale derivante dalle attività aziendali. POLIMOR s.r.l., con l'ottenimento della

certificazione UNI EN ISO 14001:2004 rilasciata da TÜV, conferma la propria filosofia aziendale, garantendo rispetto per l'ambiente ed eco-sostenibilità, attraverso un controllo delle cause e degli effetti ambientali correlate alle proprie attività produttive.

POLIMOR & SICUREZZA IN AMBIENTE DI LAVORO

La certificazione ISO 45001-2018 (Occupational Health and Safety Assessment Series) attesta l'applicazione volontaria, all'interno di un'organizzazione, di un sistema che permette di garantire un adeguato controllo riguardo alla Sicurezza e la Salute dei Lavoratori, oltre al rispetto

delle norme cogenti.

Attraverso questa certificazione, rilasciata da TÜV, POLIMOR può:

- 1) garantire il rispetto della norma alla salute dei lavoratori e di conseguenza accrescere i livelli di sicurezza;
- 2) garantire un approccio sistemico e preordinato alle emergenze derivate da infortuni ed incidenti;
- 3) migliorare l'immagine aziendale verso il cliente esterno e gli stakeholders garantendo maggior affidabilità nella gestione dei rischi relativi alla salute e sicurezza dei lavoratori, secondo un modello organizzativo riconosciuto a livello internazionale.



POLIMOR AND PRODUCTION

Polimor has obtained the UNI EN ISO 9001:2008 certification, issued by TÜV corporation, as a warranty of constant commitment to achieve the quality targets and in search of mutual satisfaction with customers and suppliers

POLIMOR AND THE ENVIRONMENT

The protection of the environment is today an issue of crucial importance. The UNI EN ISO 14001 international regulation is the most widespread and intentional instrument of environment management used for the prevention and reduction of environmental impact coming from companies. Polimor, with the achievement of the UNI

EN ISO 14001:2004 certification, issued by TÜV confirms its own company philosophy, granting respect for the environment and eco-sustainability, through a control of the environmental cause and effect related to its own productive activities.

POLIMOR AND SAFETY IN WORKING ENVIRONMENT

The ISO 45001-2018 certification (occupational Health and Safety Assessment Series) certifies the voluntary application of a method allowing to grant an adequate control in terms of the workers' safety and health, besides the respect of compulsory regulations.

Through this certification issued by TÜV, Polimor can:

- 1) Guarantee the respect for the regulation of workers' health and consequently increase the safety levels
- 2) Guarantee a systemic and prearranged approach to the emergencies coming from injuries and accidents
- 3) Improve the company image towards the customer and the stakeholders, granting a higher reliability in the management of risks, related to the workers' health and safety, according to an organizational model internationally acknowledged.

Le nostre finiture

Our colors

Verranno considerate anche richieste di finiture particolari.

Requests for special colours will be taken in consideration.

Cromo lucido
Bright Chrome



Platinato cromo
Mat Chrome



Spazzolato
Brushed



Crea il tuo catalogo on line.

Online catalogue

Polimor.it

SITO WEB POLIMOR;

nuova funzione stampa PDF.
Il sito web Polimor si arricchisce di una nuova funzionalità permettendo all'utente di stampare in autonomia le schede prodotto in formato PDF sia nel formato di SINGOLA SCHEDA che nel formato di CATALOGO PERSONALIZZATO.

Ci sono due funzioni disponibili per la stampa nel formato digitale PDF:
STAMPA SCHEDA SINGOLA
CREA IL TUO CATALOGO
Ovviamente tutti i documenti PDF generati e salvati potranno essere ulteriormente stampati se necessario in cartaceo. (NON SPRECCARE - Presta attenzione e riduci comunque il consumo della carta)

POLIMOR WEBSITE;

new PDF printing function.
The Polimor website is enriched with a new functionality allowing the user to independently print product sheets in PDF format both in the SINGLE CARD format and in the CUSTOMIZED CATALOG format.

There are two functions available for printing in the digital PDF format:
PRINT SINGLE CARD
CREATE YOUR CATALOG
Obviously all PDF documents generated and saved can be further printed if necessary in paper form. (DO NOT WASTE - Pay attention and reduce paper consumption anyway)

Scansiona il QrCode
Scan the QrCode

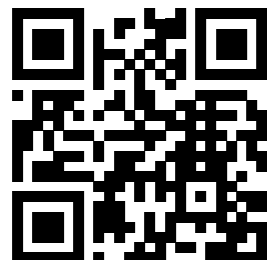

Le nostre divisioni

Our division

Polimor per rendere ai suoi cliente, più fruibile e chiara la proposta di prodotti, ha rivisto l'assetto aziendale in termini di organizzazione produttiva. Per questo motivo gli stessi strumenti di presentazione dei prodotti (vedi catalogo web sito online) sono stati riprogettati e presentati nelle TRE DIVISIONI AZIENDALI:

DIVISIONE METALLO
DIVISIONE PLASTICA
DIVISIONE BORDO A SPESSORE

To make the product offering more accessible and clear to its customers, Polimor has revised the company structure in terms of production organisation. For this reason, the same product presentation tools (see online website catalogue) have been redesigned and presented in the THREE COMPANY DIVISIONS:

METAL DIVISION
PLASTIC DIVISION
EDGEBANDING DIVISION

Scansiona il QrCode
Scan the QrCode

Divisione METALLO

METAL DIVISION



Divisione PLASTICA

PLASTIC DIVISION

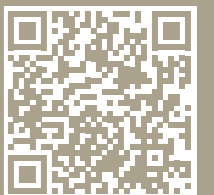

Divisione BORDI

PLASTIC DIVISION



Maniglie Stampate

Injected Handles



MZ2299 Materiale / Material: Metal
Largh. / Width: 59 mm. Lungh. / Length 76 mm. Alt. / Height 21 mm.
Interasse / Cd 64 mm.

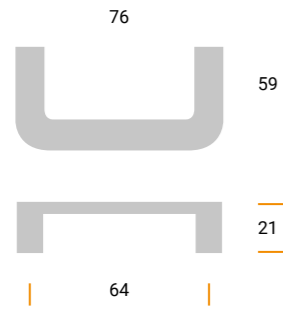

MZ2287 Materiale / Material: Metal
Largh. / Width: 8 mm. Lungh. / Length 343 mm. Alt. / Height 34 mm.
Interasse / Cd 320 mm.

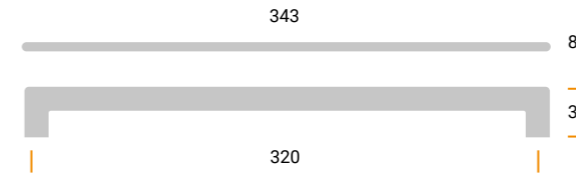

MZ2285 Materiale / Material: Metal
Largh. / Width: 8 mm. Lungh. / Length 183 mm. Alt. / Height 34 mm.
Interasse / Cd 160 mm.

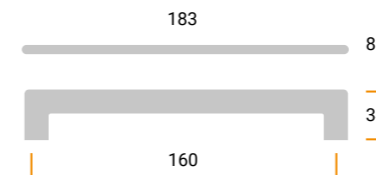

MZ2265 Materiale / Material: Metal
Largh. / Width: 25 mm. Lungh. / Length 60 mm. Alt. / Height 21 mm.
Interasse / Cd 32 mm.

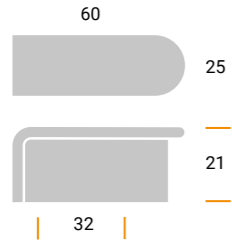

MZ2262 Materiale / Material: Metal
Largh. / Width: 17,5 mm. Lungh. / Length 103 mm. Alt. / Height 17,8 mm.
Interasse / Cd 96 mm.

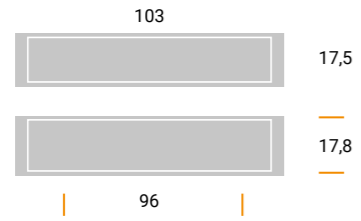

MZ2259 Materiale / Material: Metal
Largh. / Width: 38 mm. Lungh. / Length 80 mm. Alt. / Height 5 mm.
Interasse / Cd 32 mm.

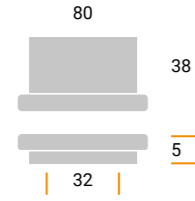

MZ2200 Materiale / Material: Metal
Largh. / Width: 11 mm. Lungh. / Length 176 mm. Alt. / Height 26,5 mm.
Interasse / Cd 160 mm.



MZ2309 Materiale / Material: Metal
Largh. / Width: 10 mm. Lungh. / Length 140,5 mm. Alt. / Height 30 mm.
Interasse / Cd 128 mm.

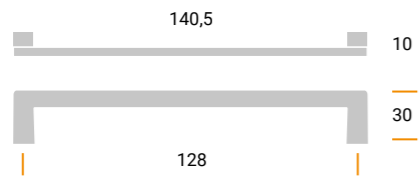

MZ2193/F Materiale / Material: Metal
 Largh. / Width: 41,5 mm. Lungh. / Length 180 mm. Alt. / Height 19 mm.
 Interasse / Cd 96/160 mm.

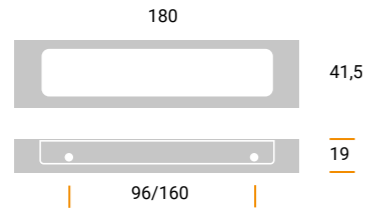

MZ2186 Materiale / Material: Metal
 Largh. / Width: 20 mm. Lungh. / Length 200,8 mm. Alt. / Height 25,8 mm.
 Interasse / Cd 160 mm.

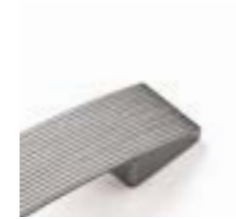
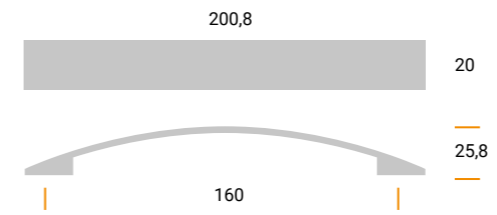

MZ2182 Materiale / Material: Metal
 Largh. / Width: 36,7 mm. Lungh. / Length 77,5 mm. Alt. / Height 25,5 mm.
 Interasse / Cd 64 mm.

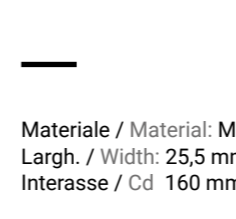
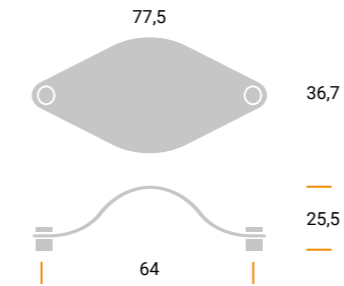

MZA2178 Materiale / Material: Metal
 Largh. / Width: 25,5 mm. Lungh. / Length 192 mm. Alt. / Height 20,5 mm.
 Interasse / Cd 160 mm.

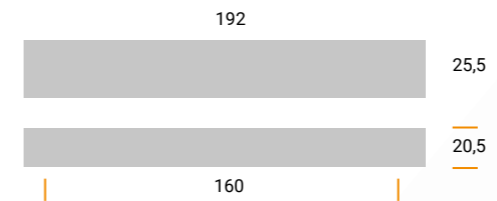

MZ2319 Materiale / Material: Metal
Largh. / Width: 14 mm. Lungh. / Length 158,6 mm. Alt. / Height 32 mm.
Interasse / Cd 128 mm.

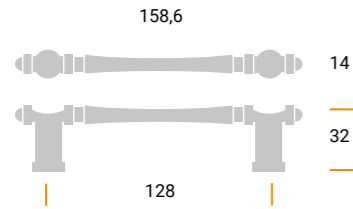

MZ2305 Materiale / Material: Metal
Diam. / Diam.: 33,6 mm. Alt. / Height 26,6 mm.
Interasse / Cd 0 mm.

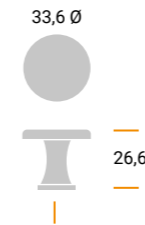

MZ2316 Materiale / Material: Metal
Diam. / Diam.: 32 mm. Alt. / Height 30,6 mm.
Interasse / Cd 0 mm.

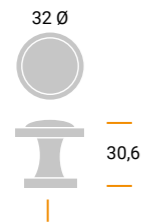

MZ2307 Materiale / Material: Metal
Largh. / Width: 29,6 mm. Lungh. / Length 29,6 mm. Alt. / Height 27,7 mm.
Interasse / Cd 0 mm.

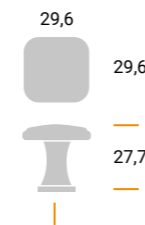

MZ2141 Materiale / Material: Metal
Largh. / Width: 21 mm. Lungh. / Length 111 mm. Alt. / Height 24,8 mm.
Interasse / Cd 96 mm.

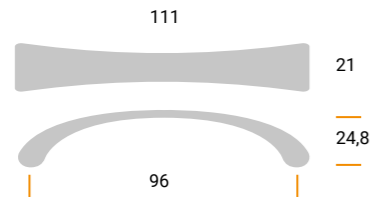

MZ2150T1 Materiale / Material: Metal
MZ2150 Largh. / Width: 14,5 mm. Lungh. / Length 186 mm. Alt. / Height 29,5 mm.
Interasse / Cd 160 mm.

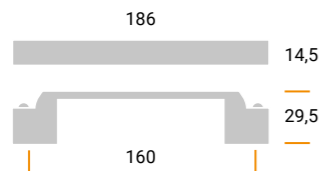

MZ2145 Materiale / Material: Metal
Largh. / Width: 29 mm. Lungh. / Length 198,5 mm. Alt. / Height 26 mm.
Interasse / Cd 160 mm.

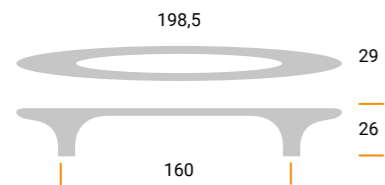

MZA2140 Materiale / Material: Metal
Largh. / Width: 23 mm. Lungh. / Length 207,5 mm. Alt. / Height 26 mm.
Interasse / Cd 160 mm.

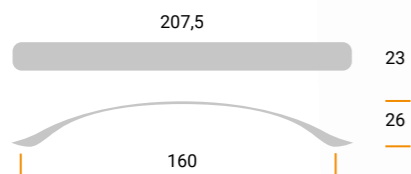

MZA2135 Materiale / Material: Metal
Largh. / Width: 24 mm. Lungh. / Length 196 mm. Alt. / Height 24 mm.
Interasse / Cd 160 mm.



MZA2115 Materiale / Material: Metal
Diametro / Diameter 12 mm. Alt. / Height 25 mm.
Interasse / Cd 0 mm.



MZA2111 Materiale / Material: Metal
Largh. / Width: 18 mm. Lungh. / Length 210 mm. Alt. / Height 16 mm.
Interasse / Cd 128/160 mm.

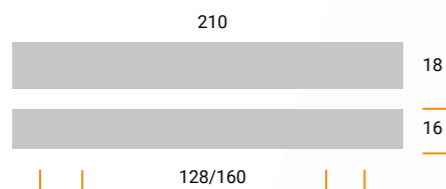

MZA2108 Materiale / Material: Metal
Largh. / Width: 8,5 mm. Lungh. / Length 353 mm. Alt. / Height 27 mm.
Interasse / Cd 320 mm.

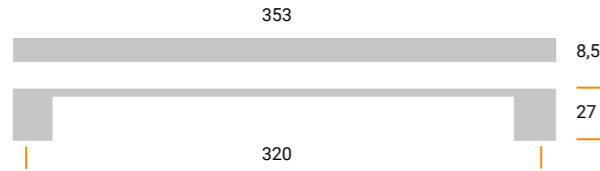

MZA2106 Materiale / Material: Metal
Largh. / Width: 8,5 mm. Lungh. / Length 161 mm. Alt. / Height 27 mm.
Interasse / Cd 128 mm.

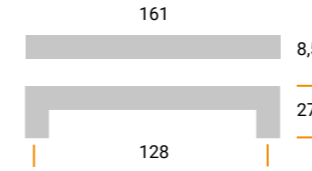

MZA2107 Materiale / Material: Metal
Largh. / Width: 8,5 mm. Lungh. / Length 257 mm. Alt. / Height 27 mm.
Interasse / Cd 224 mm.

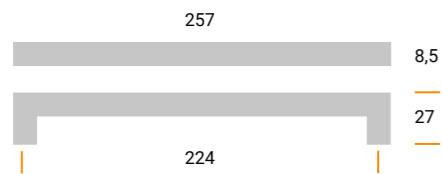

MZA2105 Materiale / Material: Metal
Largh. / Width: 8,5 mm. Lungh. / Length 193 mm. Alt. / Height 27 mm.
Interasse / Cd 160 mm.



MZA2104 Materiale / Material: Metal
Largh. / Width: 8,5 mm. Lungh. / Length 129 mm. Alt. / Height 27 mm.
Interasse / Cd 96 mm.

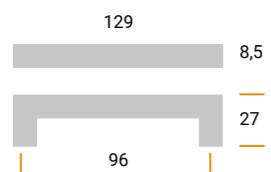

MZ2103 Materiale / Material: Metal
Largh. / Width: 10 mm. Lungh. / Length 340,5 mm. Alt. / Height 28 mm.
Interasse / Cd 320 mm.

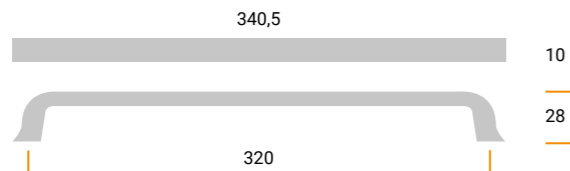

MZ2100 Materiale / Material: Metal
Largh. / Width: 10 mm. Lungh. / Length 177 mm. Alt. / Height 27 mm.
Interasse / Cd 160 mm.

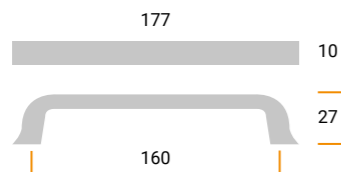

MZA2098 Materiale / Material: Metal
Largh. / Width: 16,5 mm. Lungh. / Length 374 mm. Alt. / Height 24 mm.
Interasse / Cd 320 mm.

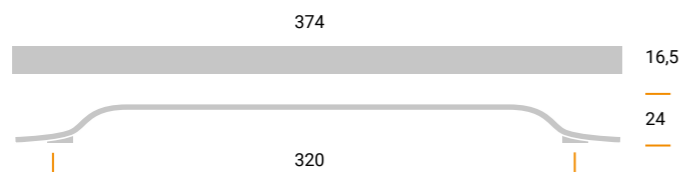

MZA2095 Materiale / Material: Metal
Largh. / Width: 16,5 mm. Lungh. / Length 214 mm. Alt. / Height 24 mm.
Interasse / Cd 160 mm.

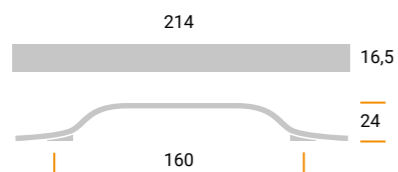

MZ2057 Materiale / Material: Metal
Largh. / Width: 15,5 mm. Lungh. / Length 330 mm. Alt. / Height 29 mm.
Interasse / Cd 320 mm.

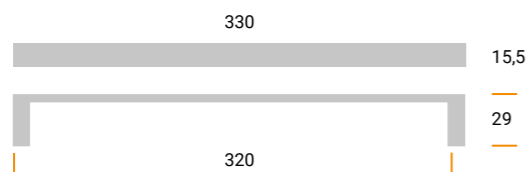

MZ2055 Materiale / Material: Metal
Largh. / Width: 15,5 mm. Lungh. / Length 170 mm. Alt. / Height 29 mm.
Interasse / Cd 160 mm.

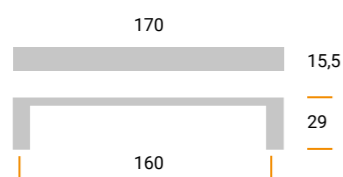

MZ2042 Materiale / Material: Metal
Largh. / Width: 10 mm. Lungh. / Length 332,5 mm. Alt. / Height 30 mm.
Interasse / Cd 320 mm.

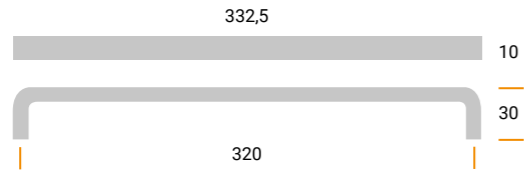

MZ2040 Materiale / Material: Metal
Largh. / Width: 10 mm. Lungh. / Length 173 mm. Alt. / Height 29 mm.
Interasse / Cd 160 mm.

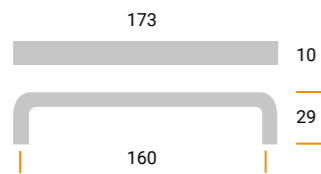

MZ2037 Materiale / Material: Metal
Largh. / Width: 11 mm. Lungh. / Length 350 mm. Alt. / Height 26,5 mm.
Interasse / Cd 320 mm.

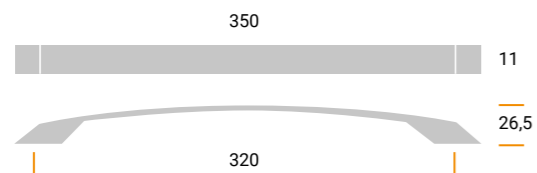

MZ2035 Materiale / Material: Metal
Largh. / Width: 10 mm. Lungh. / Length 190 mm. Alt. / Height 26,5 mm.
Interasse / Cd 160 mm.

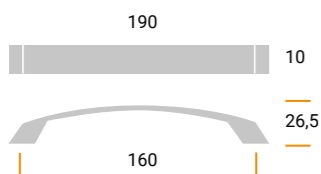

MZ2025/F Materiale / Material: Metal
 Largh. / Width: 31,8 mm. Lungh. / Length 150 mm. Alt. / Height 8 mm.
 Interasse / Cd 96 mm.

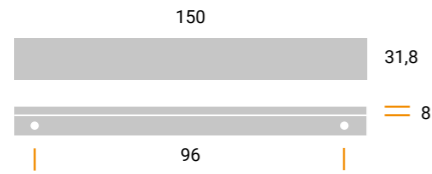

Lungh. / Length Interasse / Cd
 A richiesta / By request



MZ1990 Materiale / Material: Metal
 Largh. / Width: 17 mm. Lungh. / Length 170 mm. Alt. / Height 28 mm.
 Interasse / Cd 160 mm.

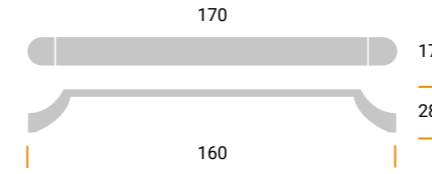

MZA2010 Materiale / Material: Metal
 Largh. / Width: 12 mm. Lungh. / Length 172 mm. Alt. / Height 35 mm.
 Interasse / Cd 160 mm.

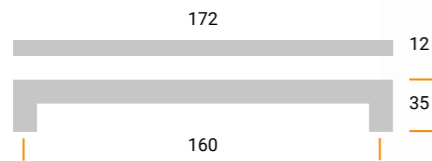

MZ1993 Materiale / Material: Metal
 Largh. / Width: 20 mm. Lungh. / Length 195,5 mm. Alt. / Height 30 mm.
 Interasse / Cd 160 mm.

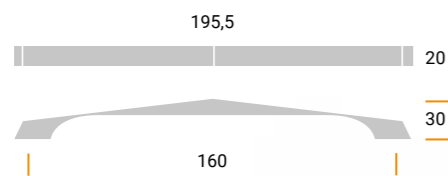

MZA1954 Materiale / Material: Metal
Largh. / Width: 17 mm. Lungh. / Length 380 mm. Alt. / Height 33 mm.
Interasse / Cd 256 mm.

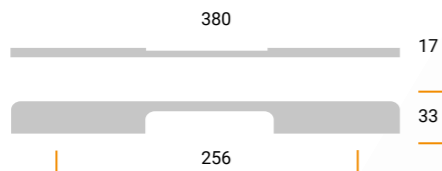

MZA1950 Materiale / Material: Metal
Largh. / Width: 17 mm. Lungh. / Length 194 mm. Alt. / Height 33 mm.
Interasse / Cd 128 mm.

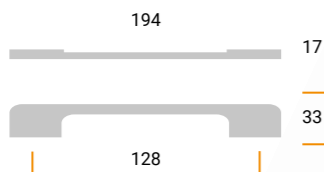

MZ1945 Materiale / Material: Metal
Largh. / Width: 17 mm. Lungh. / Length 187 mm. Alt. / Height 29 mm.
Interasse / Cd 160 mm.

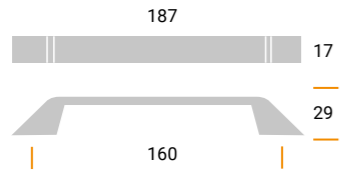

MZ1935 Materiale / Material: Metal
Largh. / Width: 17 mm. Lungh. / Length 177 mm. Alt. / Height 28 mm.
Interasse / Cd 160 mm.

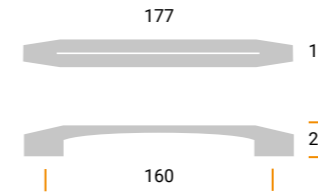

MZ1940 Materiale / Material: Metal
Largh. / Width: 44 mm. Lungh. / Length 83,5 mm. Alt. / Height 25,7 mm.
Interasse / Cd 32 mm.

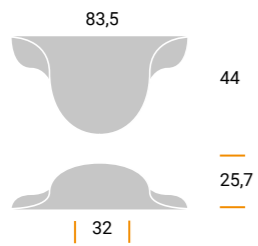

MZA1910 Materiale / Material: Metal
Largh. / Width: 25 mm. Lungh. / Length 153 mm. Alt. / Height 27 mm.
Interasse / Cd 128 mm.

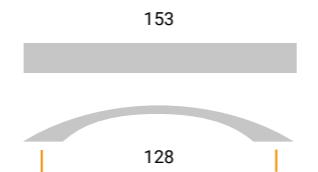

MZA1916 Materiale / Material: Metal
Largh. / Width: 24 mm. Lungh. / Length 201 mm. Alt. / Height 28 mm.
Interasse / Cd 160 mm.

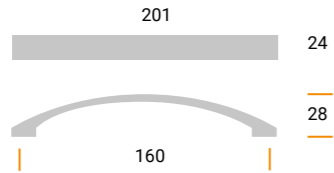

MZ1875 Materiale / Material: Metal
Largh. / Width: 32 mm. Lungh. / Length 170 mm. Alt. / Height 31 mm.
Interasse / Cd 160 mm.

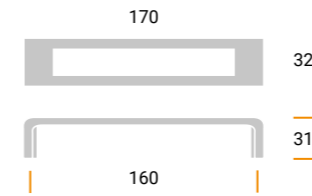

MZ1870 Materiale / Material: Metal
Largh. / Width: 24,5 mm. Lungh. / Length 233 mm. Alt. / Height 27 mm.
Interasse / Cd 160 mm.

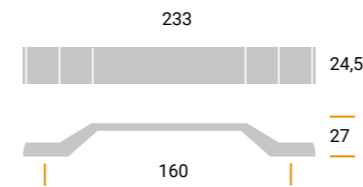

MZ1885 Materiale / Material: Metal
Largh. / Width: 15,5 mm. Lungh. / Length 197 mm. Alt. / Height 39 mm.
Interasse / Cd 160 mm.



MZ1880 Materiale / Material: Metal
Largh. / Width: 20 mm. Lungh. / Length 185 mm. Alt. / Height 28 mm.
Interasse / Cd 160 mm.

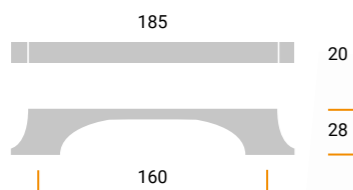

MZ1825 Materiale / Material: Metal
Largh. / Width: 20 mm. Lungh. / Length 138 mm. Alt. / Height 29 mm.
Interasse / Cd 128 mm.

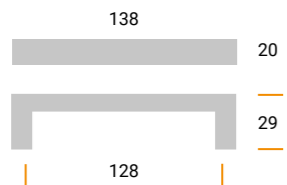

MZ1780 Materiale / Material: Metal
Largh. / Width: 18 mm. Lungh. / Length 180 mm. Alt. / Height 28 mm.
Interasse / Cd 160 mm.

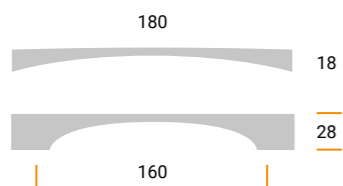

MZ1740 Materiale / Material: Metal + ABS
Largh. / Width: 72 mm. Lungh. / Length 144 mm. Alt. / Height 18 mm.
Interasse / Cd 0 mm.

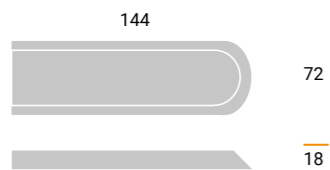

Maniglia incasso
Built in handle

Disponibile in diverse finiture
Available in different finishes

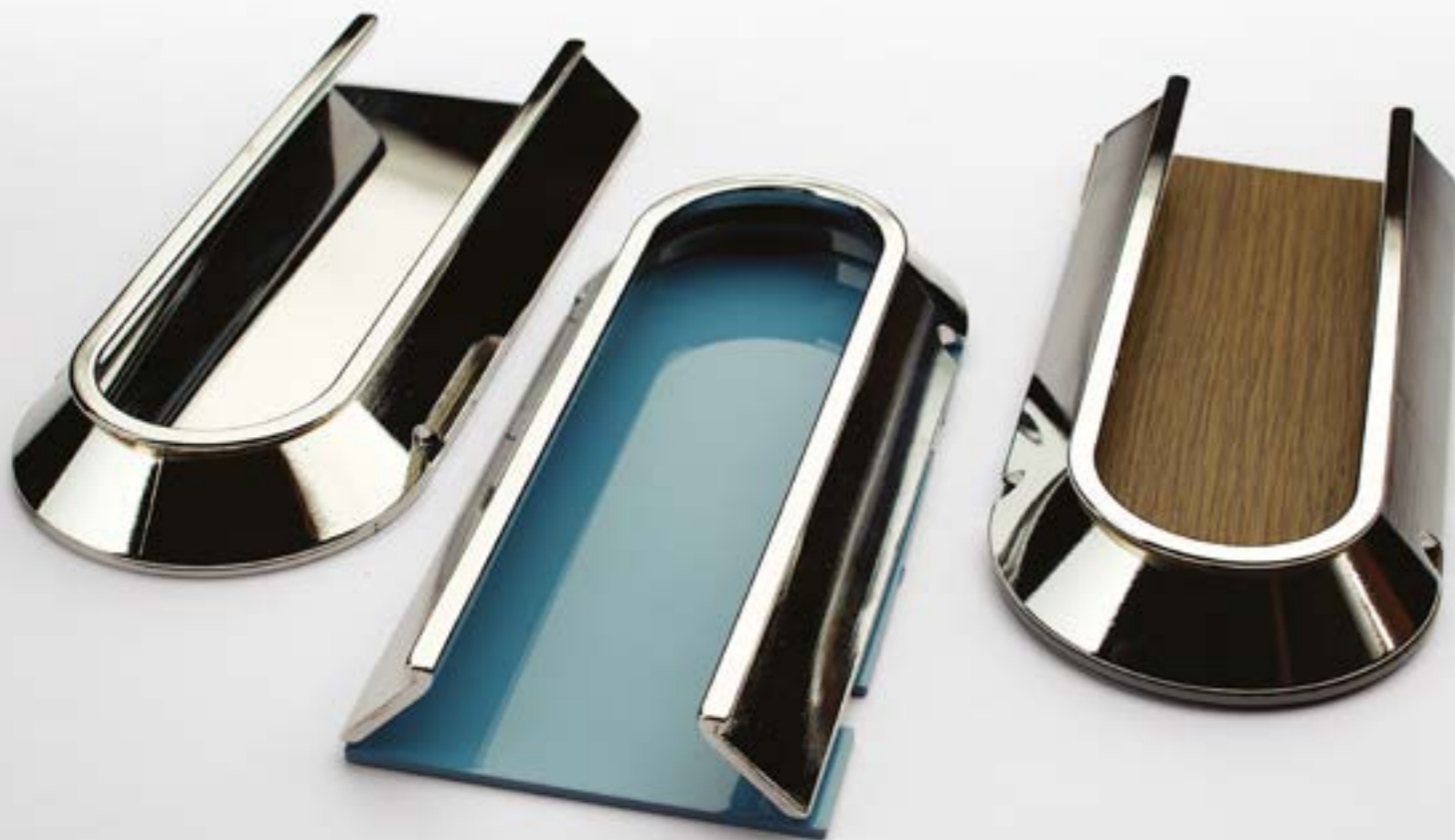

MZ1776 Materiale / Material: Metal
Largh. / Width: 30,3 mm. Lungh. / Length 142 mm. Alt. / Height 25 mm.
Interasse / Cd 96 mm.

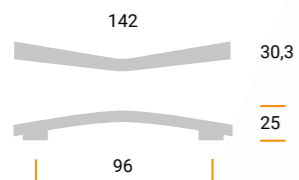

MZ1777 Materiale / Material: Metal
Largh. / Width: 35,3 mm. Lungh. / Length 171,5 mm. Alt. / Height 26 mm.
Interasse / Cd 128 mm.

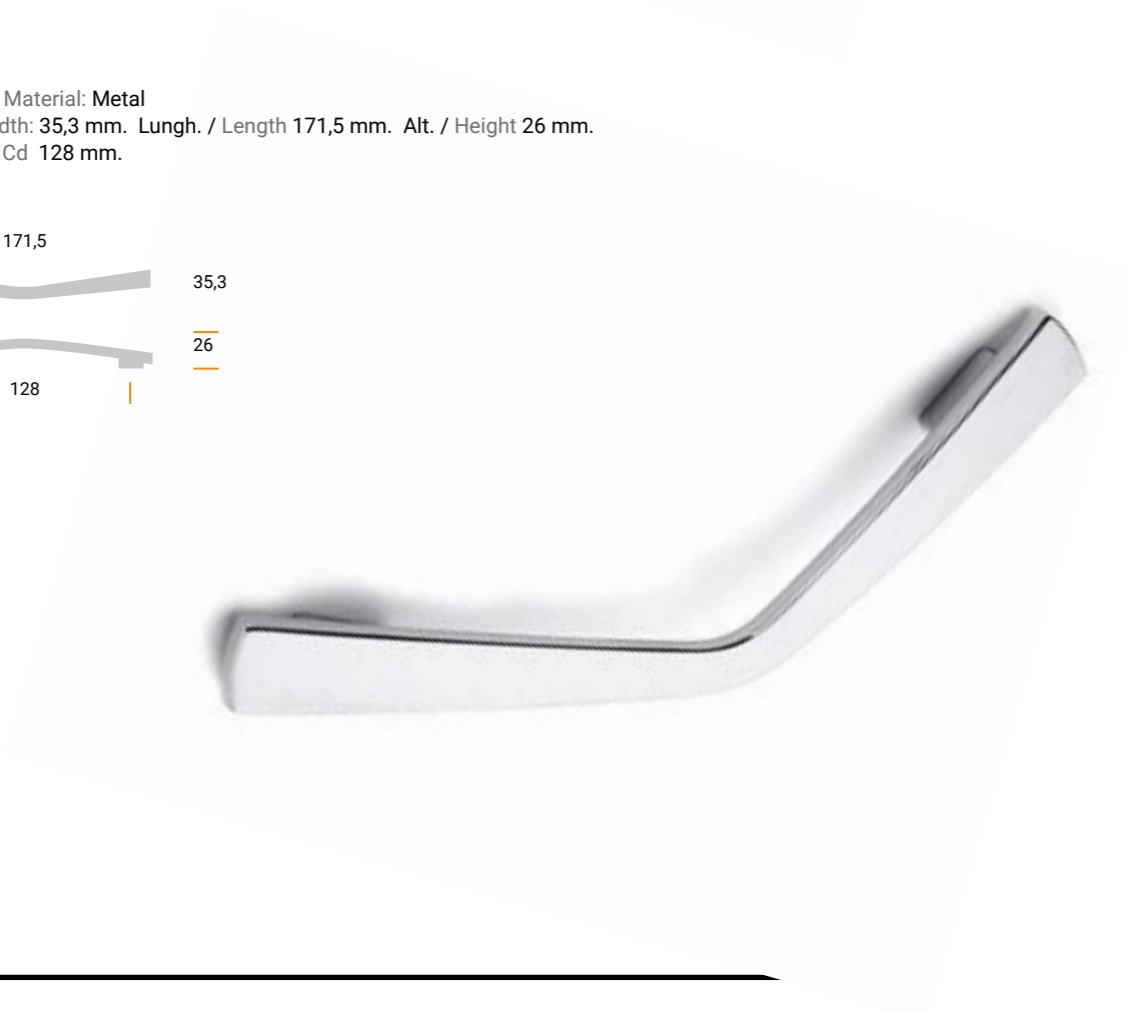
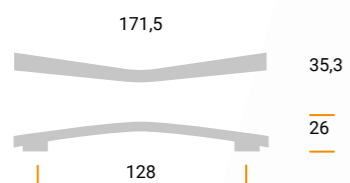

MZ1771 Materiale / Material: Metal
 Largh. / Width: 13 mm. Lungh. / Length 150 mm. Alt. / Height 23,5 mm.
 Interasse / Cd 128 mm.

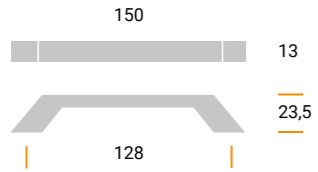

MZ1772 Materiale / Material: Metal
 Largh. / Width: 13 mm. Lungh. / Length 182 mm. Alt. / Height 23,5 mm.
 Interasse / Cd 160 mm.

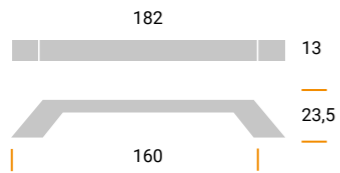

MZ1774 Materiale / Material: Metal
 Largh. / Width: 13 mm. Lungh. / Length 348 mm. Alt. / Height 28 mm.
 Interasse / Cd 320 mm.

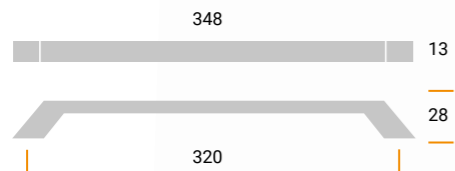

MZ1762 Materiale / Material: Metal
Largh. / Width: 14 mm. Lungh. / Length 108,5 mm. Alt. / Height 32 mm.
Interasse / Cd 96 mm.

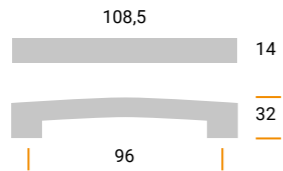

MZ1766 Materiale / Material: Metal
Largh. / Width: 14,5 mm. Lungh. / Length 332,5 mm. Alt. / Height 34 mm.
Interasse / Cd 320 mm.

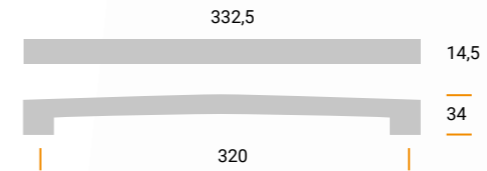

MZ1764 Materiale / Material: Metal
Largh. / Width: 14,5 mm. Lungh. / Length 172,5 mm. Alt. / Height 34 mm.
Interasse / Cd 160 mm.

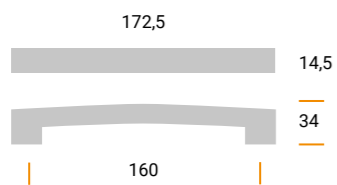

MZ1703 Materiale / Material: Metal
Largh. / Width: 27,9 mm. Lungh. / Length 385 mm. Alt. / Height 28,6 mm.
Interasse / Cd 320 mm.

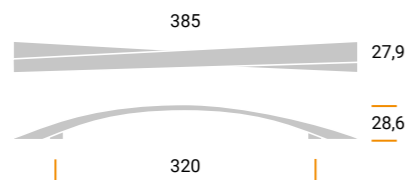

MZ1700 Materiale / Material: Metal
Largh. / Width: 21,6 mm. Lungh. / Length 213,2 mm. Alt. / Height 26,4 mm.
Interasse / Cd 160 mm.

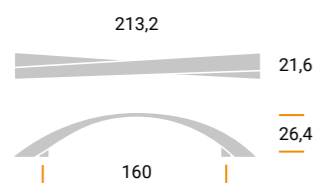

MZ1670 Materiale / Material: Metal
 Largh. / Width: 27,5 mm. Lungh. / Length 205,4 mm. Alt. / Height 25,5 mm.
 Interasse / Cd 160 mm.

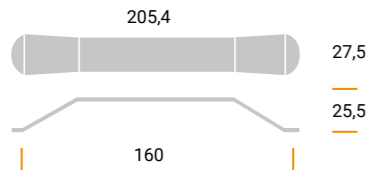

MZ1665 Materiale / Material: Metal
 Largh. / Width: 23,25 mm. Lungh. / Length 240,4 mm. Alt. / Height 26,8 mm.
 Interasse / Cd 160 mm.

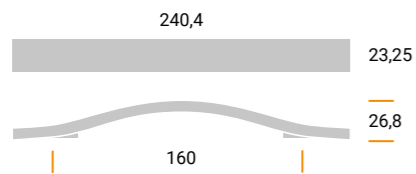

MZ1663 Materiale / Material: Metal
 Largh. / Width: 23,2 mm. Lungh. / Length 164 mm. Alt. / Height 27,4 mm.
 Interasse / Cd 96 mm.

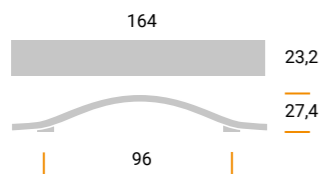

MZ1661 Materiale / Material: Metal
Largh. / Width: 11 mm. Lungh. / Length 327,6 mm. Alt. / Height 25,25 mm.
Interasse / Cd 256/320 mm.

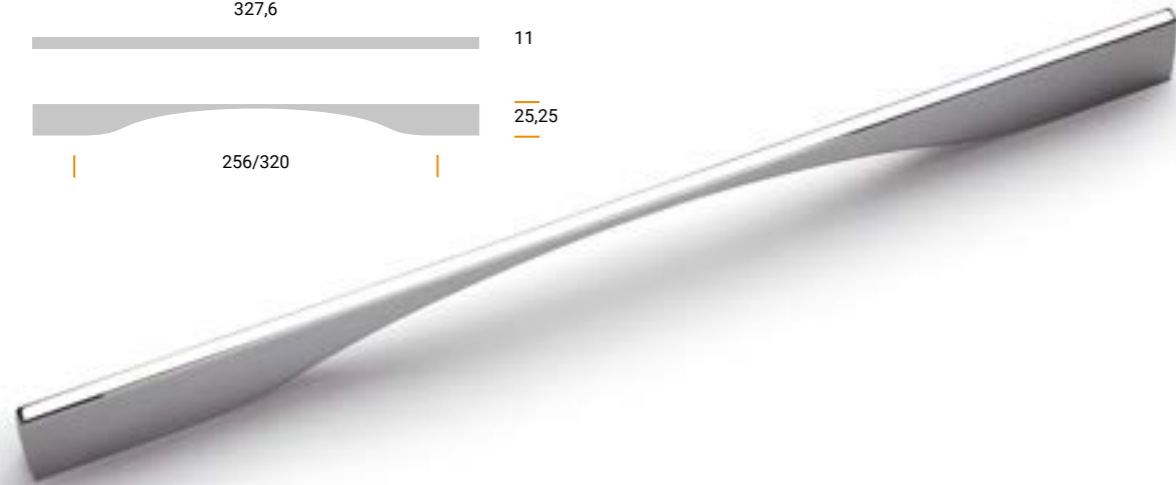
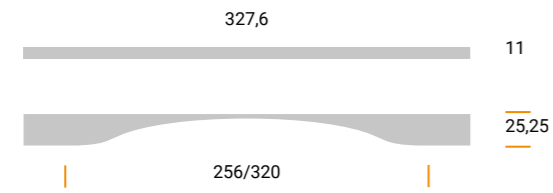

MZ1659 Materiale / Material: Metal
Largh. / Width: 11 mm. Lungh. / Length 171 mm. Alt. / Height 23,75 mm.
Interasse / Cd 128/160 mm.

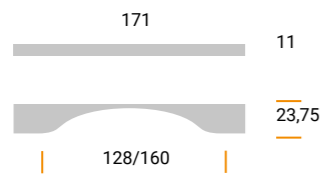

MZ1655 Materiale / Material: Metal
Largh. / Width: 17 mm. Lungh. / Length 189 mm. Alt. / Height 26 mm.
Interasse / Cd 160 mm.

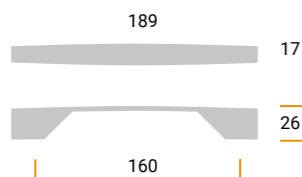

MZ1643 Materiale / Material: Metal
Largh. / Width: 25 mm. Lungh. / Length 183 mm. Alt. / Height 23,5 mm.
Interasse / Cd 160 mm.

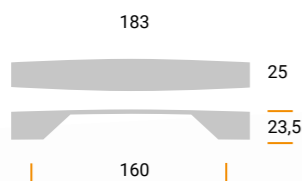

MZ1625 Materiale / Material: Metal
Largh. / Width: 45 mm. Lungh. / Length 90 mm. Alt. / Height 28 mm.
Interasse / Cd 32 mm.

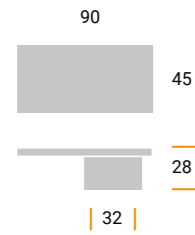

MZ1538 Materiale / Material: Metal
Largh. / Width: 40 mm. Lungh. / Length 213 mm. Alt. / Height 20,5 mm.
Interasse / Cd 160 mm.

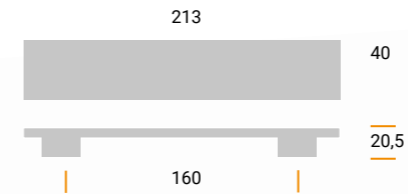

MZ1558/F Materiale / Material: Metal
Largh. / Width: 39 mm. Lungh. / Length 120 mm. Alt. / Height 21 mm.
Interasse / Cd 96 mm. (2 fori / 2 holes)

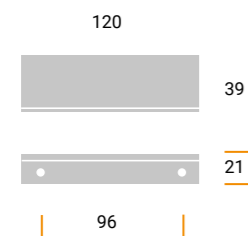

MZ1535 Materiale / Material: Metal
Largh. / Width: 53 mm. Lungh. / Length 53 mm. Alt. / Height 20,5 mm.
Interasse / Cd 0/32 mm.
Doppio interasse / Double centre distance

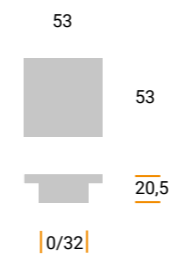

MZ1545 Materiale / Material: Metal
Largh. / Width: 52 mm. Lungh. / Length 199,8 mm. Alt. / Height 24,5 mm.
Interasse / Cd 160 mm.

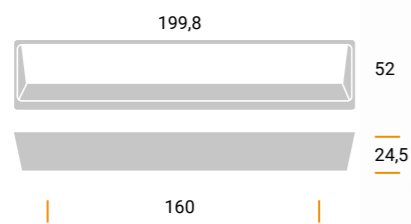

MZ1541 Materiale / Material: Metal
Largh. / Width: 79 mm. Lungh. / Length 78,5 mm. Alt. / Height 22,5 mm.
Interasse / Cd 32 mm.

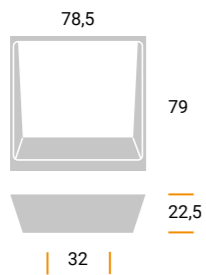

MZ1542 Materiale / Material: Metal
Largh. / Width: 52 mm. Lungh. / Length 54 mm. Alt. / Height 24,5 mm.
Interasse / Cd 32 mm.

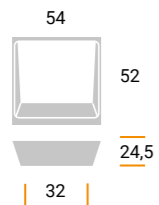

MZ1470 Materiale / Material: Metal
Largh. / Width: 39,5 mm. Lungh. / Length 335,5 mm. Alt. / Height 18 mm.
Interasse / Cd 320 mm.

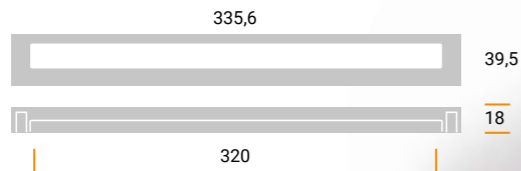

MZ1463 Materiale / Material: Metal
Largh. / Width: 39,5 mm. Lungh. / Length 175,5 mm. Alt. / Height 18,3 mm.
Interasse / Cd 160 mm.

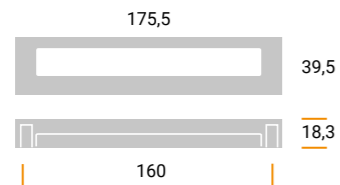

MZ1462 Materiale / Material: Metal
Largh. / Width: 39,5 mm. Lungh. / Length 143,5 mm. Alt. / Height 18,3 mm.
Interasse / Cd 128 mm.

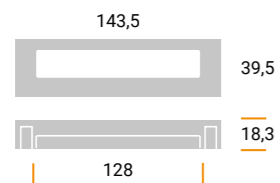

MZ1460 Materiale / Material: Metal
Largh. / Width: 47,5 mm. Lungh. / Length 39,5 mm. Alt. / Height 18,3 mm.
Interasse / Cd 32 mm.

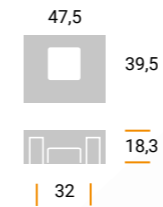

MZ1399 Materiale / Material: Metal
Largh. / Width: 23 mm. Lungh. / Length 341 mm. Alt. / Height 28,2 mm.
Interasse / Cd 256 mm.

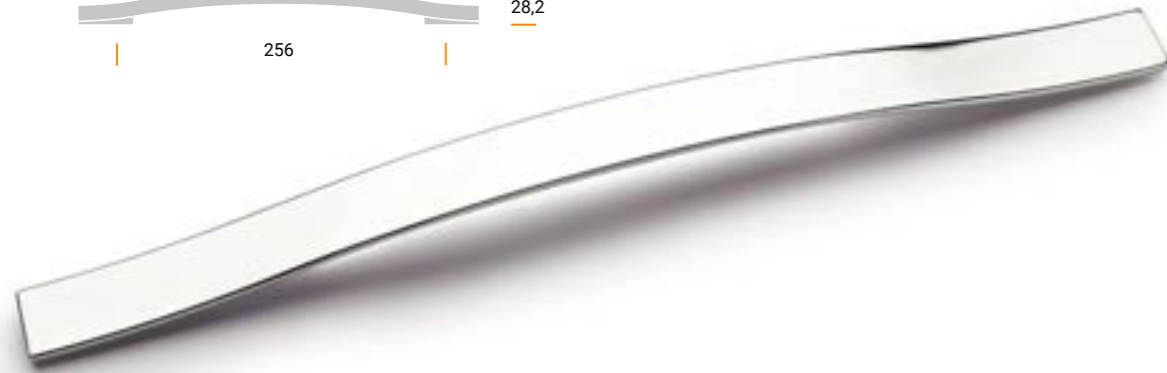
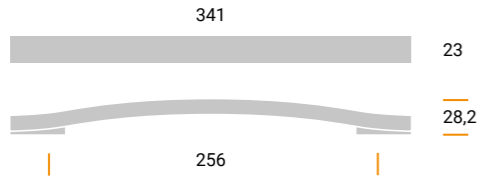

MZ1397 Materiale / Material: Metal
Largh. / Width: 23 mm. Lungh. / Length 216 mm. Alt. / Height 28,2 mm.
Interasse / Cd 160 mm.

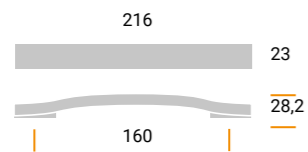

MZ1392 Materiale / Material: Metal
 Largh. / Width: 22,15 mm. Lungh. / Length 286,5 mm. Alt. / Height 26,5 mm.
 Interasse / Cd 256 mm.

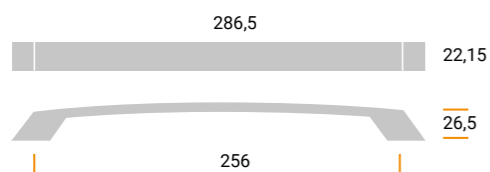

MZ1390 Materiale / Material: Metal
 Largh. / Width: 22,15 mm. Lungh. / Length 190,35 mm. Alt. / Height 26 mm.
 Interasse / Cd 160 mm.

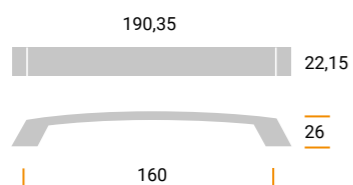

MZ1377 Materiale / Material: Metal
 Largh. / Width: 10,7 mm. Lungh. / Length 337,5 mm. Alt. / Height 16,5 mm.
 Interasse / Cd 256 (128+128) mm.

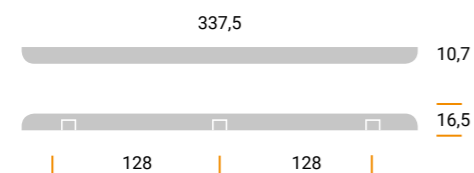

MZ1375 Materiale / Material: Metal
 Largh. / Width: 10,7 mm. Lungh. / Length 177,5 mm. Alt. / Height 16,5 mm.
 Interasse / Cd 160 mm.

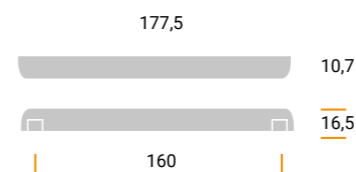

MZ1318 Materiale / Material: Metal
 Largh. / Width: 20 mm. Lungh. / Length 198 mm. Alt. / Height 25 mm.
 Interasse / Cd 128/96 mm.

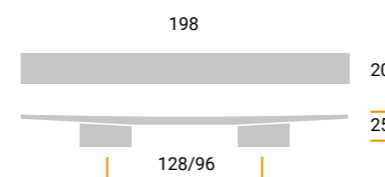

MZ1316 Materiale / Material: Metal
 Largh. / Width: 20 mm. Lungh. / Length 102 mm. Alt. / Height 16,6 mm.
 Interasse / Cd 32 mm.

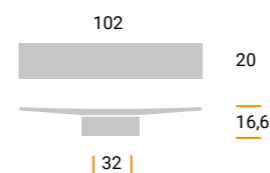

MZ1388 Materiale / Material: Metal
Largh. / Width: 14,5 mm. Lungh. / Length 343,5 mm. Alt. / Height 25 mm.
Interasse / Cd 320 mm.

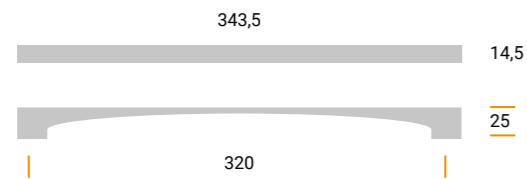

MZ1385 Materiale / Material: Metal
Largh. / Width: 14,5 mm. Lungh. / Length 178,5 mm. Alt. / Height 25 mm.
Interasse / Cd 160 mm.

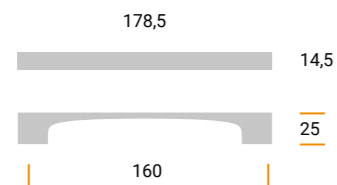

MZ1383 Materiale / Material: Metal
Largh. / Width: 14,5 mm. Lungh. / Length 112,5 mm. Alt. / Height 25 mm.
Interasse / Cd 96 mm.

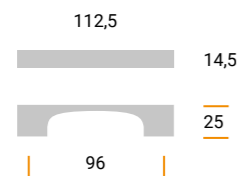

MZ1295 Materiale / Material: Metal
Largh. / Width: 10,6 mm. Lungh. / Length 349 mm. Alt. / Height 25,5 mm.
Interasse / Cd 320 mm.



MZ1230 Materiale / Material: Metal
Largh. / Width: 7,2 mm. Lungh. / Length 328 mm. Alt. / Height 18 mm.
Interasse / Cd 320 mm.

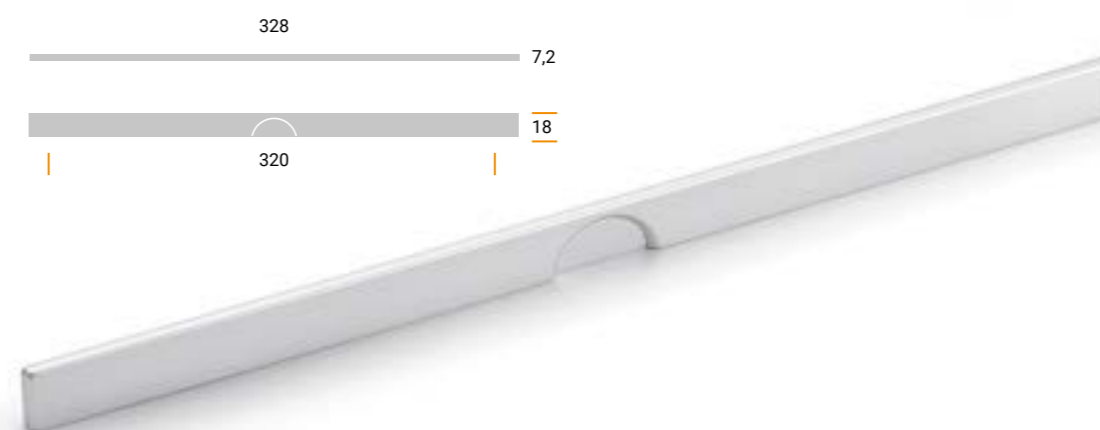

MZ1292 Materiale / Material: Metal
Largh. / Width: 10,6 mm. Lungh. / Length 189 mm. Alt. / Height 23,5 mm.
Interasse / Cd 160 mm.



MZ1227 Materiale / Material: Metal
Largh. / Width: 7,2 mm. Lungh. / Length 116 mm. Alt. / Height 16 mm.
Interasse / Cd 96 mm.



MZ1255 Materiale / Material: Metal
Largh. / Width: 31 mm. Lungh. / Length 135 mm. Alt. / Height 26 mm.
Interasse / Cd 128 mm.



MZ1226 Materiale / Material: Metal
Largh. / Width: 7,2 mm. Lungh. / Length 54 mm. Alt. / Height 16 mm.
Interasse / Cd 32 mm.



MZ1218 Materiale / Material: Metal
Largh. / Width: 9 mm. Lungh. / Length 210 mm. Alt. / Height 22 mm.
Interasse / Cd 128 mm.



MZ1216 Materiale / Material: Metal
Largh. / Width: 8 mm. Lungh. / Length 101,5 mm. Alt. / Height 22 mm.
Interasse / Cd 32/64 mm.

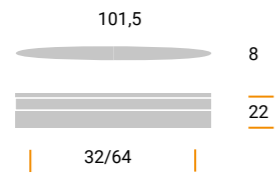

MZ1214 Materiale / Material: Metal
Largh. / Width: 6 mm. Lungh. / Length 35,3 mm. Alt. / Height 22 mm.
Interasse / Cd 0 mm.

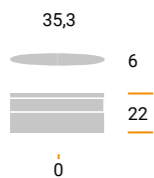

MZ1221 Materiale / Material: Metal
Largh. / Width: 30 mm. Lungh. / Length 328,5 mm. Alt. / Height 26,2 mm.
Interasse / Cd 320 mm.

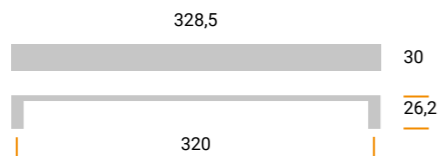

MZ1220 Materiale / Material: Metal
Largh. / Width: 30 mm. Lungh. / Length 168 mm. Alt. / Height 26,2 mm.
Interasse / Cd 160 mm.

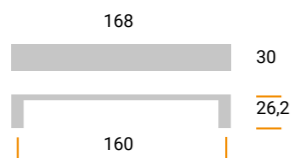

MZ1565 Materiale / Material: Metal
 Largh. / Width: 29,5 mm. Lungh. / Length 368 mm. Alt. / Height 32,15 mm.
 Interasse / Cd 320 mm.

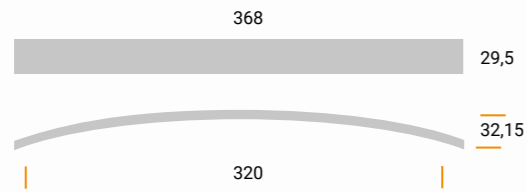

MZ1198 Materiale / Material: Metal
 Largh. / Width: 28,5 mm. Lungh. / Length 165 mm. Alt. / Height 24,2 mm.
 Interasse / Cd 128 mm.

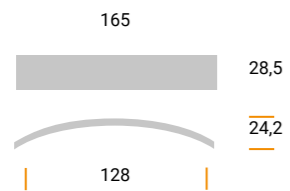

MZ1161 Materiale / Material: Metal
 Largh. / Width: 28,1 mm. Lungh. / Length 50 mm. Alt. / Height 20,4 mm.
 Interasse / Cd 32 mm.

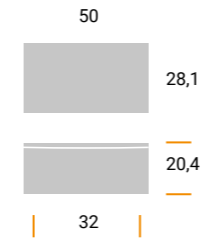

MZ1160 Materiale / Material: Metal
 Largh. / Width: 27 mm. Lungh. / Length 27 mm. Alt. / Height 20 mm.
 Interasse / Cd 0 mm.

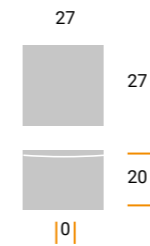

MZ1148 Materiale / Material: Metal
 Largh. / Width: 50 mm. Lungh. / Length 50 mm. Alt. / Height 22 mm.
 Interasse / Cd 32 mm.

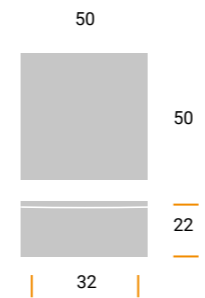

MZ1153 Materiale / Material: Metal
Largh. / Width: 9,4 mm. Lungh. / Length 105,7 mm. Alt. / Height 20,5 mm.
Interasse / Cd 96 mm.

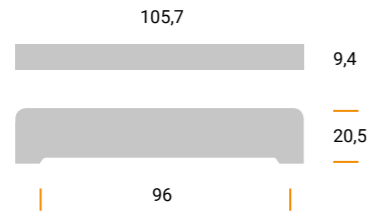

MZ1105 Materiale / Material: Metal
Largh. / Width: 23 mm. Lungh. / Length 235,3 mm. Alt. / Height 27 mm.
Interasse / Cd 160 mm.

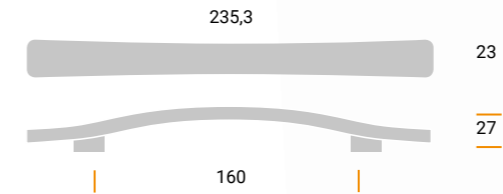

MZ1131 Materiale / Material: Metal
Largh. / Width: 19 mm. Lungh. / Length 136 mm. Alt. / Height 21,7 mm.
Interasse / Cd 96 mm.

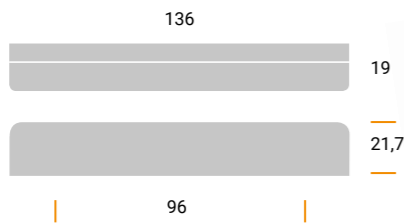

MZ1103 Materiale / Material: Metal
Largh. / Width: 19 mm. Lungh. / Length 139,5 mm. Alt. / Height 24 mm.
Interasse / Cd 96 mm.

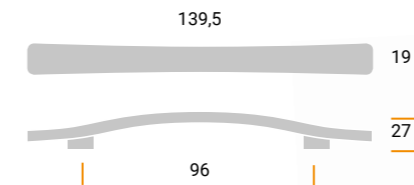

MZ1130 Materiale / Material: Metal
Largh. / Width: 19 mm. Lungh. / Length 60 mm. Alt. / Height 21,7 mm.
Interasse / Cd 32 mm.

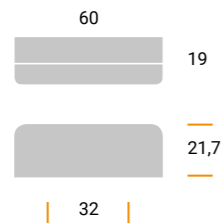

MZ1107 Materiale / Material: Metal
Largh. / Width: 12 mm. Lungh. / Length 136 mm. Alt. / Height 22,5 mm.
Interasse / Cd 128 mm.

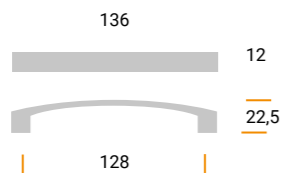

MZ1110 Materiale / Material: Metal
Largh. / Width: 12 mm. Lungh. / Length 331 mm. Alt. / Height 26 mm.
Interasse / Cd 320 mm.

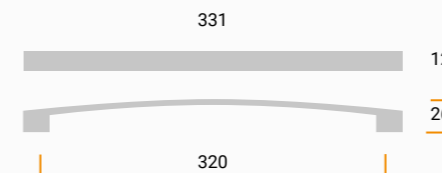

MZ1108 Materiale / Material: Metal
Largh. / Width: 12 mm. Lungh. / Length 173 mm. Alt. / Height 22,5 mm.
Interasse / Cd 160 mm.

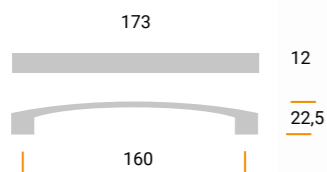

MZ1090 Materiale / Material: Metal
Largh. / Width: 28 mm. Lungh. / Length 168,9 mm. Alt. / Height 31,5 mm.
Interasse / Cd 160 mm.

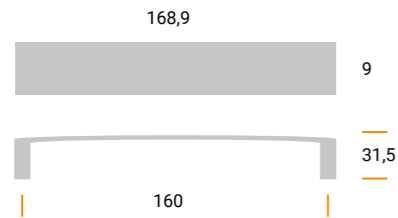

MZ1089 Materiale / Material: Metal
Largh. / Width: 28 mm. Lungh. / Length 136,9 mm. Alt. / Height 31,5 mm.
Interasse / Cd 128 mm.

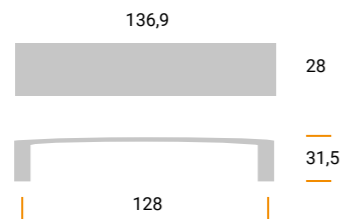

MZ1076 Materiale / Material: Metal
Largh. / Width: 22,4 mm. Lungh. / Length 182,7 mm. Alt. / Height 28,1 mm.
Interasse / Cd 160 mm.

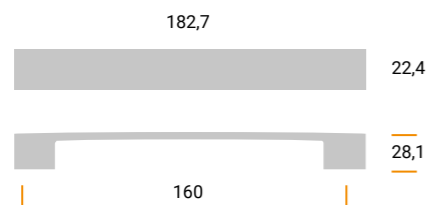

MZ1072 Materiale / Material: Metal
Largh. / Width: 26 mm. Lungh. / Length 175 mm. Alt. / Height 28,2 mm.
Interasse / Cd 160 mm.

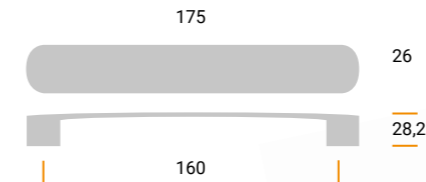

MZ1015 Materiale / Material: Metal
 Largh. / Width: 12 mm. Lungh. / Length 12 mm. Alt. / Height 22,5 mm.
 Interasse / Cd 0 mm.

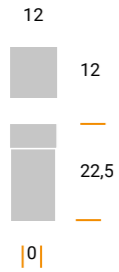

MZ1012 Materiale / Material: Metal
 Largh. / Width: 23,9 mm. Lungh. / Length 156 mm. Alt. / Height 26,8 mm.
 Interasse / Cd 128 mm.

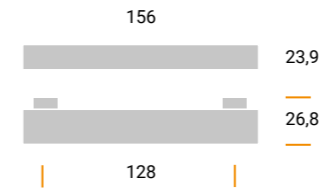

MZ1011 Materiale / Material: Metal
 Largh. / Width: 23,8 mm. Lungh. / Length 150 mm. Alt. / Height 21,5 mm.
 Interasse / Cd 128 mm.

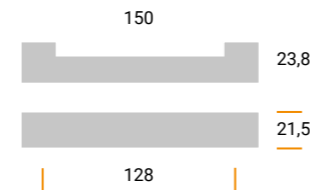

MZ1013 Materiale / Material: Metal
 Largh. / Width: 23,9 mm. Lungh. / Length 156 mm. Alt. / Height 26,8 mm.
 Interasse / Cd 128 mm.

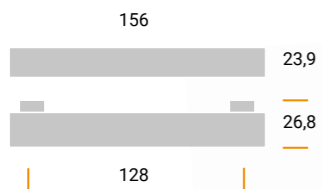

MZ1010 Materiale / Material: Metal
 Largh. / Width: 23,8 mm. Lungh. / Length 150 mm. Alt. / Height 21,5 mm.
 Interasse / Cd 128 mm.

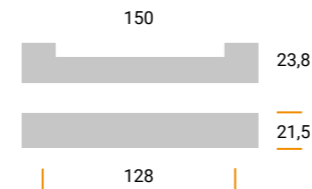

MZ1006 Materiale / Material: Metal
Largh. / Width: 31 mm. Lungh. / Length 184 mm. Alt. / Height 28,7 mm.
Interasse / Cd 160 mm.



MZ1002 Materiale / Material: Metal
Largh. / Width: 28,5 mm. Lungh. / Length 165 mm. Alt. / Height 25,2 mm.
Interasse / Cd 128 mm.



MZ1005 Materiale / Material: Metal
Largh. / Width: 28,5 mm. Lungh. / Length 165 mm. Alt. / Height 25 mm.
Interasse / Cd 128 mm.



MZ992 Materiale / Material: Metal
Largh. / Width: 22,8 mm. Lungh. / Length 201 mm. Alt. / Height 25 mm.
Interasse / Cd 128 mm.



MZ1003 Materiale / Material: Metal
Largh. / Width: 31 mm. Lungh. / Length 184 mm. Alt. / Height 27,7 mm.
Interasse / Cd 160 mm.



MZ991 Materiale / Material: Metal
Largh. / Width: 23 mm. Lungh. / Length 201 mm. Alt. / Height 25 mm.
Interasse / Cd 128 mm.



MZ975 Materiale / Material: Metal
Largh. / Width: 22,2 mm. Lungh. / Length 265 mm. Alt. / Height 27 mm.
Interasse / Cd 256 mm.

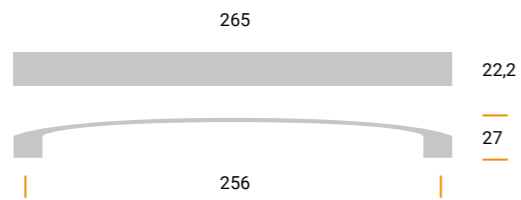

MZ973 Materiale / Material: Metal
Largh. / Width: 22 mm. Lungh. / Length 173 mm. Alt. / Height 26 mm.
Interasse / Cd 160 mm.

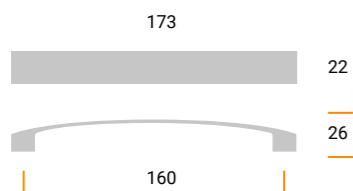

MZ972 Materiale / Material: Metal
Largh. / Width: 22 mm. Lungh. / Length 108,4 mm. Alt. / Height 25 mm.
Interasse / Cd 96 mm.

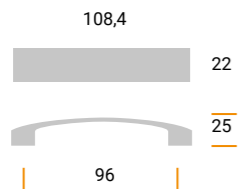

MZ988 Materiale / Material: Metal
 Largh. / Width: 7 mm. Lungh. / Length 105,4 mm. Alt. / Height 30 mm.
 Interasse / Cd 96 mm.

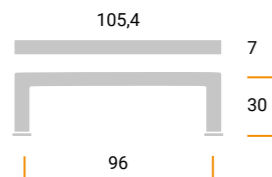

MZ971 Materiale / Material: Metal
 Largh. / Width: 12 mm. Lungh. / Length 329 mm. Alt. / Height 23,9 mm.
 Interasse / Cd 320 mm.

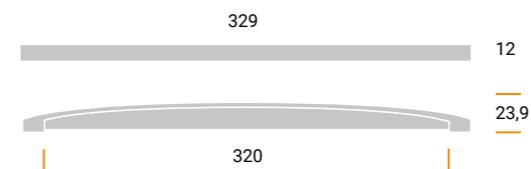

MZ971c Materiale / Material: Metal
 Largh. / Width: 12 mm. Lungh. / Length 332 mm. Alt. / Height 24,5 mm.
 Interasse / Cd 320 mm.

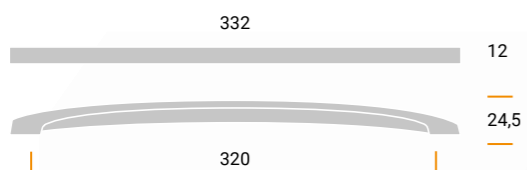

Maniglia per anta curva: R. 638 mm. / Handle curved door: R. 638 mm.

MZ968 Materiale / Material: Metal
 Largh. / Width: 12 mm. Lungh. / Length 136 mm. Alt. / Height 21,4 mm.
 Interasse / Cd 128 mm.

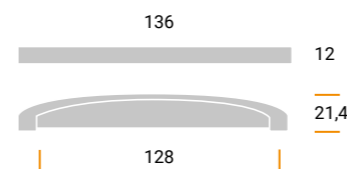

MZ961b

Materiale / Material: Metal
 Largh. / Width: 12 mm. Lungh. / Length 179 mm. Alt. / Height 22,5 mm.
 Interasse / Cd 160 mm.

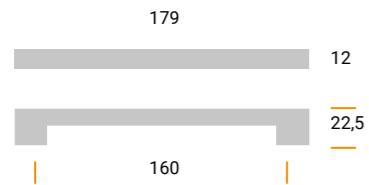

MZ959b

Materiale / Material: Metal
 Largh. / Width: 12 mm. Lungh. / Length 115 mm. Alt. / Height 22,5 mm.
 Interasse / Cd 96 mm.

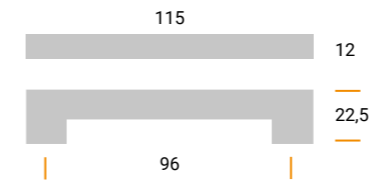

Maniglia per anta curva: R. 638 mm. / Handle curved door: R. 638 mm.

MZ956b

Materiale / Material: Metal
 Largh. / Width: 10 mm. Lungh. / Length 51 mm. Alt. / Height 22,5 mm.
 Interasse / Cd 32 mm.

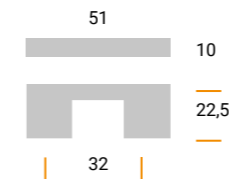

MZ960b

Materiale / Material: Metal
 Largh. / Width: 12 mm. Lungh. / Length 147 mm. Alt. / Height 22,5 mm.
 Interasse / Cd 128 mm.

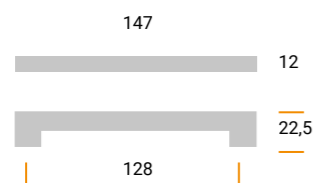

MZ955

Materiale / Material: Metal
 Largh. / Width: 12 mm. Lungh. / Length 41,2 mm. Alt. / Height 22,5 mm.
 Interasse / Cd 0 mm.

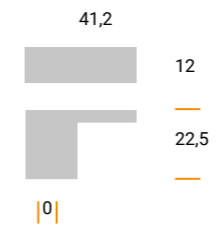

MZ961 Materiale / Material: Metal + ABS
Largh. / Width: 12 mm. Lungh. / Length 179 mm. Alt. / Height 22,5 mm.
Interasse / Cd 160 mm.

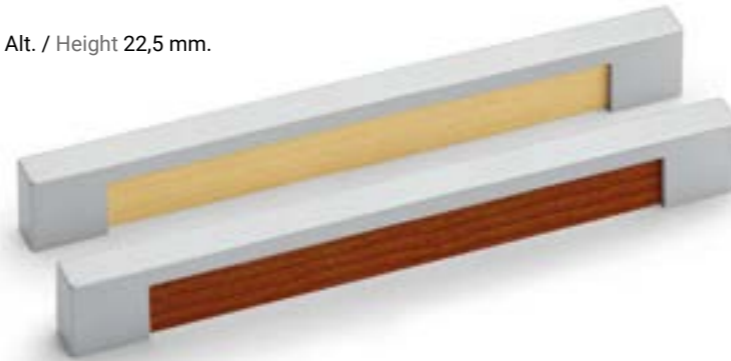
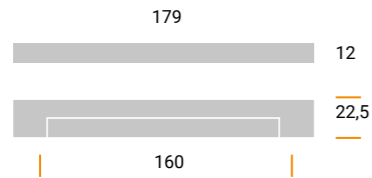

FINITURE INSERTO PLASTICA M961i / COLOURS PLASTIC INSERT M961i
Legno / Wood
Laccato colorato / Colored painted
Platinato cromo / Mat chrome

MZ960 Materiale / Material: Metal + ABS
Largh. / Width: 12 mm. Lungh. / Length 147 mm. Alt. / Height 22,5 mm.
Interasse / Cd 128 mm.

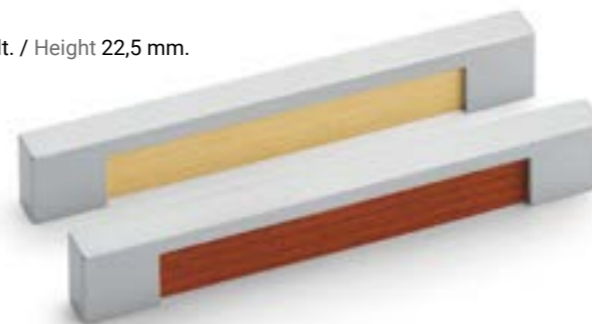
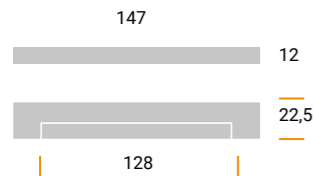

FINITURE INSERTO PLASTICA M960i / COLOURS PLASTIC INSERT M960i
Legno / Wood
Laccato colorato / Colored painted
Platinato cromo / Mat chrome

MZ959 Materiale / Material: Metal + ABS
Largh. / Width: 12 mm. Lungh. / Length 115 mm. Alt. / Height 22,5 mm.
Interasse / Cd 96 mm.

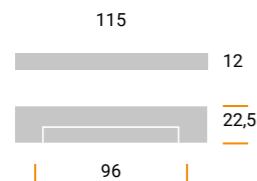

FINITURE INSERTO PLASTICA M959i / COLOURS PLASTIC INSERT M959i
Legno / Wood
Laccato colorato / Colored painted
Platinato cromo / Mat chrome

MZ956 Materiale / Material: Metal + ABS
Largh. / Width: 10 mm. Lungh. / Length 51 mm. Alt. / Height 22,5 mm.
Interasse / Cd 32 mm.

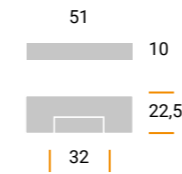

FINITURE INSERTO PLASTICA M956i / COLOURS PLASTIC INSERT M956i
Legno / Wood
Laccato colorato / Colored painted
Platinato cromo / Mat chrome

MZ931 Materiale / Material: Metal + ABS
Largh. / Width: 19,3 mm. Lungh. / Length int. + 42,5 mm. Alt. / Height 22,9 mm.
Interasse / Cd A richiesta / By request

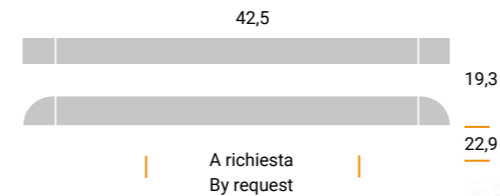

FINITURE INSERTO PLASTICA M931i / COLOURS PLASTIC INSERT M931i
Legno / Wood
Laccato colorato / Colored painted
Platinato cromo / Mat chrome

MZ920 Materiale / Material: Metal
Largh. / Width: 50 mm. Lungh. / Length 50 mm. Alt. / Height 20,9 mm.
Interasse / Cd 32 mm.

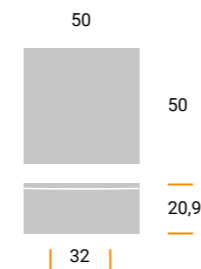

FINITURE INSERTO PLASTICA M920i / COLOURS PLASTIC INSERT M920i
Legno / Wood
Laccato colorato / Colored painted
Platinato cromo / Mat chrome

Maniglie Profilo

Profile Handles



Lavorazioni Custom

Custom machining

Le maniglie prodotte con la tecnica di estrusione dell'alluminio, vedi la gamma di maniglie a listello o regolo e la gamma di maniglie denominate a "elle" applicate nel bordo dell'anta, dopo l'estrusione possono essere ulteriormente personalizzate. Ovviamente oltre ad essere molto flessibili nella definizione delle varie lunghezze e dei vari interassi.

The handles are produced using an aluminum extrusion technique, see the range of strip or straight handles and the range of "L" shaped handles applied on the edge of the door, which after extrusion can be further customized. Obviously, in addition to being very flexible in defining the various lengths and interaxes.

Qui potrete individuare alcuni esempi di lavorazioni effettuate.

Here you can find some examples of work carried out.

Maniglie "Elle" (Fissaggio retro anta)

L handles (Rear of the door fixing)



Lavorazione di taglio dritto o inclinato
Straight or inclined cutting process



Lavorazione sagomata anch'essa con possibili silhouette differenti
Shaped workmanship also with possible different silhouettes



Lavorazione con raggio finale di varie dimensioni
Processing with a radius of various dimensions

Maniglie "Regolo"

Maniglie "Regolo" (Fissaggio retro anta)

Straight handles (Rear of the door fixing)



Lavorazione con raggio finale di varie dimensioni
Processing with a radius of various dimensions



Lavorazione sagomata nella zona di presa della maniglia
Shaped workmanship in the grip area of the handle



Lavorazione della zona di presa con varie dimensioni
Processing of the grip area with various dimensions



Lavorazione con posizione variabile della zona di presa
Machining with variable position of the gripping area



Lavorazione di taglio inclinato nella parte terminale della maniglia
Inclined cutting process on the terminal part of the handle – possibly this could be replaced with angled cutting at the ends of the handle.

MZA2326 Materiale / Material: Metal
Largh. / Width: 37 mm. Lungh. / Length On Demand
Interasse / Cd On Demand

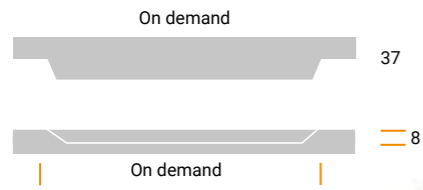

MZA2326 Esempio / Example
/118/147



MZA2326 Esempio / Example
/225/297



MZA2326 Esempio / Example
/352/397



MZA2326 Esempio / Example
/468/497



MZA2292 Materiale / Material: Metal
Largh. / Width: 18,2 mm. Lungh. / Length On Demand Alt. / Height 18,2 mm.
Interasse / Cd On Demand

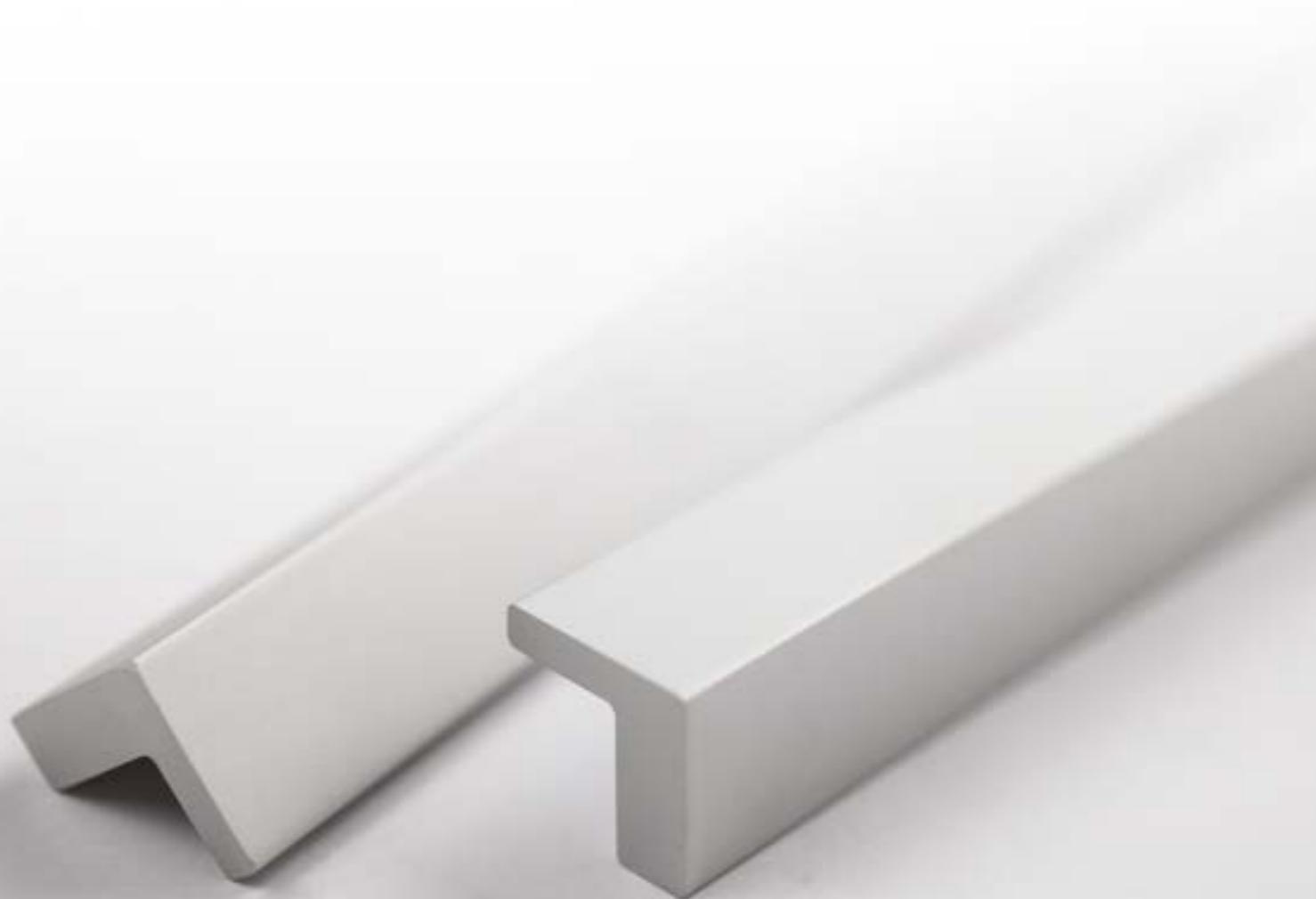

MZA2278 Materiale / Material: Metal
Largh. / Width: 10 mm. Lungh. / Length On Demand Alt. / Height 30 mm.
Interasse / Cd On Demand

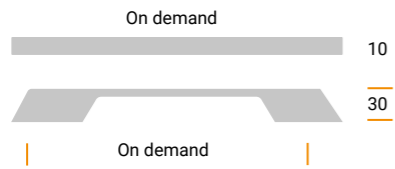

MZA2278 Esempio / Example
/96/146



MZA2278 Esempio / Example
/81/92/300



MZA2278 Esempio / Example
/192+320+320/996



MZA2256/F Materiale / Material: Metal
Largh. / Width: 44 mm. Lungh. / Length On Demand Alt. / Height 11,6 mm.
Interasse / Cd On Demand

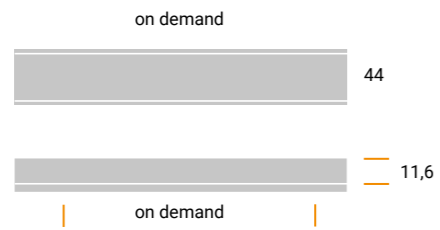

MZA2255/F Materiale / Material: Metal
Largh. / Width: 33,5 mm. Lungh. / Length On Demand Alt. / Height 6,5 mm.
Interasse / Cd On Demand



MZA2255/F Materiale / Material: Metal
Largh. / Width: 33,5 mm. Lungh. / Length On Demand Alt. / Height 6,5 mm.
Interasse / Cd On Demand
Versione taglio 20 gradi
20 degree cut

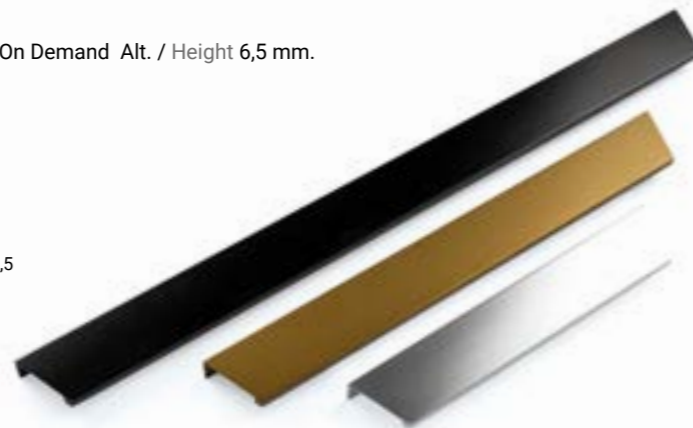

MZ2211 Materiale / Material: Metal
Largh. / Width: 11 mm. Lungh. / Length On Demand Alt. / Height 30 mm.
Interasse / Cd On Demand

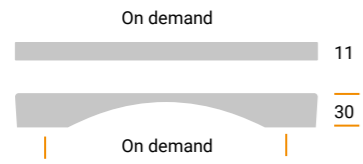

MZ2211 Esempio / Example
/96/110



MZ2211 Esempio / Example
/256/276



MZ2211 Esempio / Example
/192+352+352/990

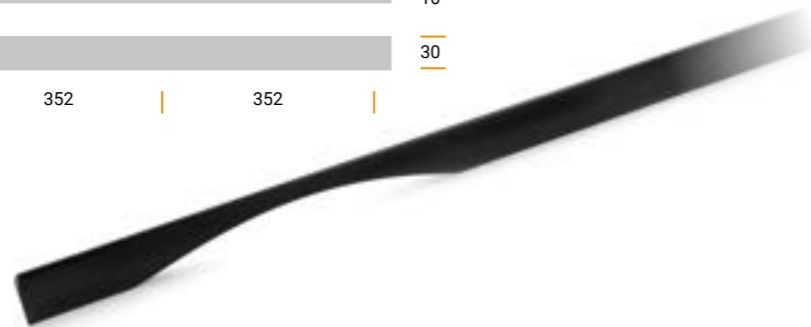
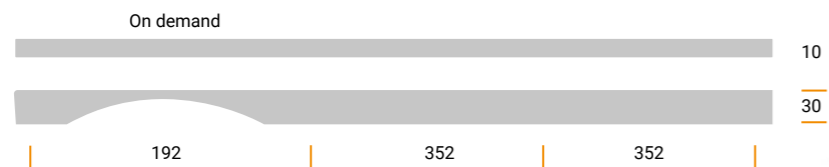

MZA2209 Materiale / Material: Zama
 Largh. / Width: 10 mm. Lungh. / Length On demand Alt. / Height 30 mm.
 Interasse / Cd On demand

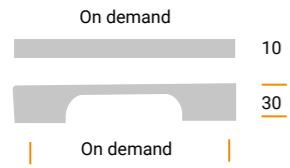

MZA2209 Esempio / Example
 /256/276

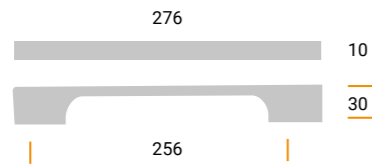

MZA2209 Esempio / Example
 /256+352+320/990

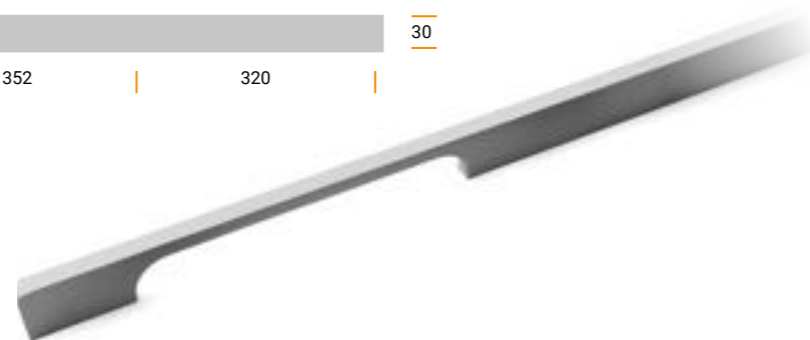
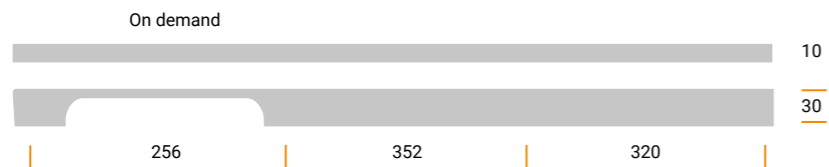

MZA2207/F Materiale / Material: Metal
 Largh. / Width: 44,5 mm. Lungh. / Length On Demand Alt. / Height 26 mm.
 Interasse / Cd On Demand

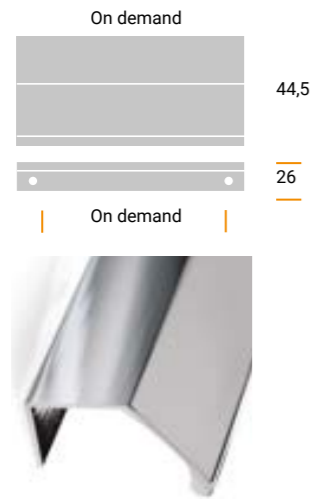

MZ2191 Materiale / Material: Zama
 Largh. / Width: 10 mm. Lungh. / Length On Demand Alt. / Height 21,5 mm.
 Interasse / Cd On Demand

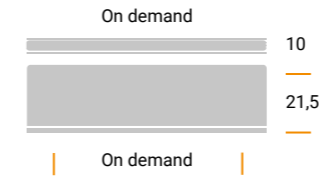

MZA2198/F Materiale / Material: Metal
 Largh. / Width: 49 mm. Lungh. / Length On Demand Alt. / Height 12,5 mm.
 Interasse / Cd On Demand

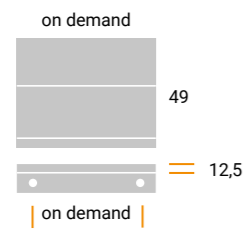

MZA2176/F

Materiale / Material: Metal
 Largh. / Width: 43 mm. Lungh. / Length On Demand Alt. / Height 12 mm.
 Interasse / Cd On Demand

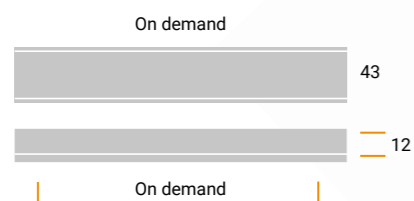

MZA2157/F

Materiale / Material: Metal
 Largh. / Width: 44 mm. Lungh. / Length 46 mm. Alt. / Height 4 mm.
 Interasse / Cd 32 mm.

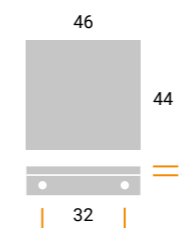

Lungh. / Length Interasse / Cd
 A richiesta / On Demand

MZA1822

Materiale / Material: Metal
 Largh. / Width: 17,5 mm. Lungh. / Length On Demand Alt. / Height 20 mm.
 Interasse / Cd On Demand

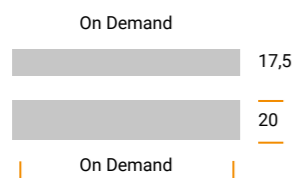

MZA2155/F

Materiale / Material: Metal
 Largh. / Width: 34 mm. Lungh. / Length On Demand Alt. / Height 4 mm.
 Interasse / Cd On Demand

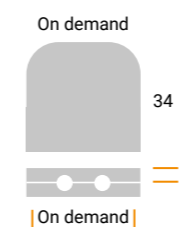

Disponibile / available
 MZA1822N Interasse / Cd 96mm Lungh. / Length 110mm
 MZA1822N Interasse / Cd 224mm Lungh. / Length 240mm
 MZA1822N Interasse / Cd 640mm Lungh. / Length 660mm

MZA1958 Materiale / Material: Metal
Largh. / Width: 12 mm. Lungh. / Length A richiesta / By request. Alt. / Height 20 mm.
Interasse / Cd A richiesta / By request



Disponibile / available
MZA1958N Interasse / Cd 160mm Lungh. / Length 180mm
MZA1958N Interasse / Cd 192mm Lungh. / Length 212mm
MZA1958N Interasse / Cd 192+192mm Lungh. / Length 554mm
MZA1958N Interasse / Cd 320+320+320mm Lungh. / Length 1088mm















Indice























Index

Maniglie Stampate Injected Handles																	
			MZA2178	21		MZ2108	30		MZ2040	40		MZ1910	49		MZ1772	60	
	MZ2299	12		MZ2319	22		MZA2107	30		MZ2037	42		MZA1916	50		MZ1774	60
	MZ2287	13		MZ2316	22		MZA2106	31		MZ2035	42		MZ1875	51		MZ1762	62
	MZ2285	13		MZ2305	23		MZA2105	32		MZ2025/F	44		MZ1870	51		MZ1764	62
	MZ2265	14		MZ2307	23		MZA2104	32		MZA2010	44		MZ1885	52		MZ1766	63
	MZ2262	16		MZ2141	24		MZ2103	34		MZ1993	44		MZ1880	52		MZ1703	64
	MZ2259	18		MZ2150T1 MZ2150	24		MZ2100	34		MZ1990	45		MZ1825	54		MZ1700	64
	MZ2200	18		MZ2145	24		MZA2098	36		MZA1954	46		MZ1780	54		MZ1670	66
	MZ2309	18		MZ2140	26		MZA2095	36		MZA1950	46		MZ1740	56		MZ1665	66
	MZ21/93	20		MZ2135	26		MZ2057	38		MZ1945	48		MZ1776	58		MZ1663	66
	MZ2186	21		MZ2115	28		MZ2055	38		MZ1940	48		MZ1777	58		MZ1661	68
	MZ2182	21		MZ2111	28		MZ2042	40		MZ1935	49		MZ1771	60		MZ1659	68

Indice

Index

 MZ1655 70	 MZ1460 77	 MZ1295 84	 MZ1198 90	 MZ1090 96	 MZ1002 101
 MZ1643 70	 MZ1399 78	 MZ1292 84	 MZ1161 91	 MZ1089 96	 MZ992 101
 MZ1625 72	 MZ1397 78	 MZ1255 84	 MZ1160 91	 MZ1076 96	 MZ991 101
 MZ1558/F 72	 MZ1392 80	 MZ1230 85	 MZ1148 91	 MZ1072 97	 MZ975 102
 MZ1538 73	 MZ1390 80	 MZ1227 85	 MZ1153 92	 MZ1015 98	 MZ973 102
 MZ1535 73	 MZ1377 80	 MZ1226 85	 MZ1131 92	 MZ1013 98	 MZ972 102
 MZ1545 74	 MZ1375 81	 MZ1218 86	 MZ1130 92	 MZ1012 99	 MZ988 104
 MZ1541 74	 MZ1318 81	 MZ1216 86	 MZ1105 93	 MZ1011 99	 MZ971C 104
 MZ1542 74	 MZ1316 81	 MZ1214 86	 MZ1103 93	 MZ1010 99	 MZ971 105
 MZ1470 76	 MZ1388 82	 MZ1221 88	 MZ1107 94	 MZ1006 100	 MZ968 105
 MZ1463 76	 MZ1385 82	 MZ1220 88	 MZ1108 94	 MZ1005 100	 MZ961B 106
 MZ1462 76	 MZ1383 82	 MZ1565 90	 MZ1110 95	 MZ1003 100	 MZ960B 106

	MZ959B 107	Maniglie Profilo Profile Handles		MZA1822 128
	MZ956B 107			MZA2157/F 129
	MZ955 107			MZA2155/F 129
	MZ961 108			MZA1958 130
	MZ960 108			
	MZ959 108			
	MZ956 109			
	MZ931 109			
	MZ920 109			
				
				
				

www.polimor.it

POLIMOR

Polimor srl
Via della Tecnologia
61122 Pesaro - Italia
Tel. +39.0721.482157
Fax +39.0721.481362
polimor@polimor.it